

PENOUEST



Aléuseuse portative SUPERCOMBINATA ELSA SC1-400

Alésage de \varnothing 42 mm à \varnothing 400 mm avec l'équipement standard



Avec les options :
 Alésage de \varnothing 25 mm à \varnothing 400 mm
 Rechargement de \varnothing 35 mm à \varnothing 400 mm

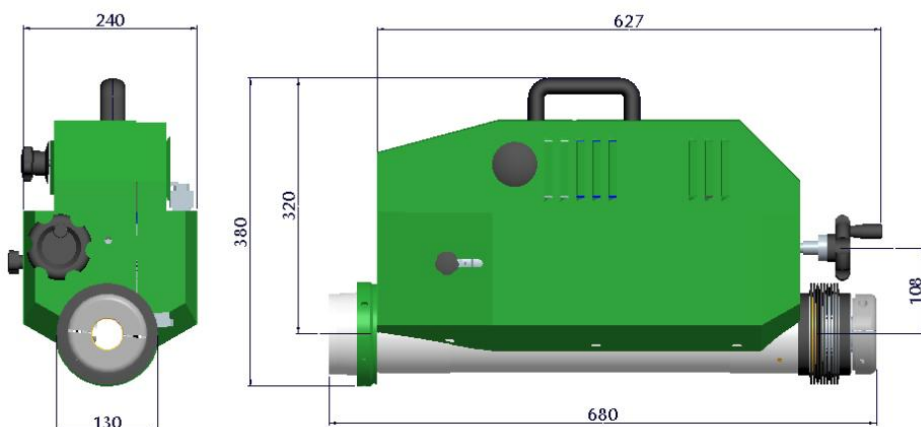

Poids unité principale :
 41 kg

Moteur pour alésage	
Puissance nominale 1800 W	Vitesses maxi de la barre 1 ^{ère}) 95 rpm 2 ^{ème}) 150 rpm 3 ^{ème}) 320 rpm 4 ^{ème}) 510 rpm

Moteur d'avance - DC			
Puissance nominale 90 W	Vitesse maximale 11 rpm	Système de l'avance électromécanique	Avancement Manuel/automatique













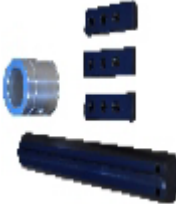

Pupitre de commande 220 V (50/60 HZ)	
Interrupteur principal de mise sous tension Interrupteur d'arrêt d'urgence Inverseur rotation d'alésage	Potentiomètre réglage vitesse de rotation Inverseur de déplacement barre ou torche Potentiomètre de vitesse de déplacement

01-17-10

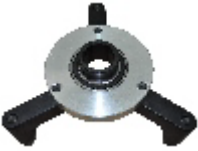



Le Kenyah nord, rue de l'avenir – 56400 Plougoumen France
 Tél : (33) 02 97 24 16 59 – E-mail : accueil@penouest.com – Site: www.penouest.com

SA au capital de 300 000 Euros – RCS Lorient B 391 833 019 – Siret 391 833 019 00014 – APE 4669 B – N° identification TVA FR 10391833019

Equipement standard de l'aléreuse **SUPERCOMBINATA SC1-400** Capacité d'alésage de \varnothing 42 mm à 400 mm

 <p>1 barre d'alésage \varnothing 40 x 2200</p>	 <p>1 allonge barre d'alésage 520 mm</p>	 <p>Centrale de commande électronique + câbles</p>	 <p>1 porte-outil \varnothing 12 long 40 GA 1 porte-outil \varnothing 12 long 60 GA 1 porte-outil \varnothing 12 long 100 DR</p>
 <p>1 boîte de 10 plaquettes</p>	 <p>1 porte-outils pour \varnothing 100 à 400 mm</p>	 <p>1 mécanisme de centrage trous borgnes</p>	 <p>1 mécanisme de centrage trous débouchant</p>
 <p>1 palier support \varnothing 40 mm</p>	 <p>1 palier intermédiaire</p>	 <p>1 jeu de clé de service</p>	 <p>1 jauge intérieure (microspand)</p>
 <p>12 bras alliage léger</p>	 <p>1 comparateur</p>	 <p>1 support comparateur</p>	 <p>1 bâti d'aléreuse</p>

OPTIONS

<p>kit de rechargement</p>  <p>1 torche de Rechargement</p> <p>1 allonge 100 mm 5 rallonges diffuseur 35 mm buses gaz : 4 courtes + 4 longues guides fil : 5 courts + 5 longs</p>	 <p>Kit alésage \varnothing 22 – 50 mm Long. barre : 2200 mm</p>	 <p>Kit alésage \varnothing 32 – 100 mm Long. barre : 1800 mm</p>	 <p>Barre d'alésage \varnothing 40 x 1100</p>
--	--	---	---

01-17-10